



**THE
ORIGINATOR
SINCE
1956**



PRODUCT GUIDE *Digital* vol. 195

OLFA CORPORATION

The OLFA snap-off blade cutter, invented in 1956, is the proven best selling and fastest moving cutting tool in the world.

- Le cutter OLFA à lame sécable, inventé en 1956 est de loin l'outil de coupe le plus rapide à manipuler et le plus vendu à travers le monde.
- Das OLFA-Abbrechmesser, das 1956 erfunden wurde, ist nachweislich das bestverkaufte und am weitesten verbreitete Schneidwerkzeug auf der Welt.
- El cortador OLFA de cuchillas desglosables, inventado en 1956 es el cortador más vendido y el de mayor velocidad de corte del mundo.

The Originator Since 1956.

The world's 1st SNAP-OFF BLADE CUTTER

- L'Auteur depuis 1956. Le 1er CUTTER AVEC LAME SÉCABLE au monde
- Der Ursprung Seit 1956. Der 1. CUTTER MIT ABKNICK-KLINGE weltweit
- El Originador desde 1956. El 1er CORTADOR DEL MUNDO CON CUCHILLA DESGLOSABLE



The Originator Since 1979.

The world's 1st ROTARY CUTTER

- L'Auteur depuis 1979. Le 1er CUTTER ROTATIF au monde
- Der Ursprung Seit 1979. Der 1. ROTATIONSCUTTER weltweit
- El Originador desde 1979. El 1er CORTADOR ROTATIVO DEL MUNDO



Mr. Yoshio OKADA (1931-1990) The founder of OLFA CORPORATION

- M. Yoshio OKADA (1931-1990) Le fondateur de OLFA CORPORATION
- Mr. Yoshio OKADA (1931-1990) Der Gründer der OLFA CORPORATION
- Sr. Yoshio OKADA (1931-1990) El fundador de OLFA CORPORATION



OLFA WORLD SALES NETWORK

The brand OLFA is recognized worldwide. We export to over 100 countries across the globe.

- La marque OLFA est reconnue dans le monde entier. Nous exportons dans plus de 100 pays à travers le monde.
- Die Marke OLFA wird weltweit anerkannt. Wir exportieren in über 100 Länder rund um den Globus.
- La marca OLFA es reconocida por todo el mundo. Exportamos a más de 100 países de todo el mundo.

Feel The Difference in Sharpness and Durability!

- Sentez la différence en termes de précision et de durée!
- Spüren Sie den Unterschied in Schärfe und Strapazierfähigkeit!
- ¡Sienta la diferencia en afilado y duración!



Traditional Silver Blade

- Lame traditionnelle en argent
- Traditionelle Silber Klinge
- Cuchilla Tradicional de Plata

25% sharper Excel Black Sharp Blade

- Lame Tranchante Excel Black 25% plus tranchante
- 25% schärfere Excel Black Sharp-Klinge
- Cuchilla Excel Black Sharp un 25% más afilada

Striking a balance between sharpness and durability.

- Trouver un équilibre entre tranchant et durabilité.
- Trifft ein Gleichgewicht zwischen Schärfe und Haltbarkeit.
- Consigue un equilibrio entre la capacidad de corte y la durabilidad.

Sharper edge for lesser resistance while cutting and cleaner finish

- Bord plus affûté pour une moindre résistance pendant la coupe ainsi qu'une finition plus nette.
- Schärfere Schneide für weniger Widerstand während des Schneidens und einen saubereren Abschluss.
- Un borde más afilado para una menor resistencia al cortar y una acabado más limpio.

EXCELBLACK
ULTRA SHARP BLADES™

The self-explaining soft yellow color similar to egg yolk makes users think of safety and familiarity.

- La couleur jaune douce auto-explicative semblable à celle d'un jaune d'œuf permet d'évoquer la sécurité et la familiarité aux utilisateurs.
- Die selbsterklärende weiche gelbe Farbe, die Eigelb ähnlich ist, gibt dem Verwender ein Gefühl von Sicherheit und Gewohnheit.
- El color auto-explicativo amarillo suave parecido a la yema de huevo hace que los usuarios piensen en seguridad y familiaridad.

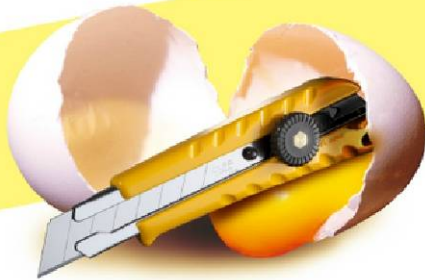

explanatory notes/legends

- notes explicatives/légendes
- erklärende Notizen/Erklärungen
- notas explicativas/leyendas

	PACKAGING ■ EMBALLAGE ■ VERPACKUNG ■ EMBALAJE		REPLACEMENT BLADE ■ LAME de RECHANGE ■ ERSATZKLINGE ■ CUCHILLA de REPUESTO		CARTON CONTENTS ■ CONTENU du CARTON ■ KARTONINHALT ■ CONTENIDO de EMBALAJE
	BLISTER PACKED ■ EMBALLAGE BLISTER ■ BLISTER PACKUNG ■ PRESENTADO en BLISTER		PLASTIC BAG ■ SÄCHET PLASTIQUE ■ KUNSTSTOFFBEUTEL ■ BOLSA de PLASTICO		PLASTIC CASE ■ ETUI PLASTIQUE ■ KUNSTSTOFFBOX ■ CAJA de PLASTICO



NEW
 ■ NOUVEAU
 ■ NEU
 ■ NUEVO



THE GOOD DESIGN AWARDED PRODUCT
 ■ PRIME MEILLEUR PRODUIT POUR SON "EXCELLENT DESIGN"
 ■ DIESES PRODUKT WURDE MIT DEM "GOOD DESIGN" PREIS AUSGEZEICHNET
 ■ PRODUCTO PREMIADO POR SU "BUEN DISEÑO"



AUTO-LOCK
 ■ VERROUILLAGE AUTOMATIQUE
 ■ AUTO-LOCK KLINGENFESTSTELLER
 ■ BLOQUEO AUTOMATICO



STAINLESS STEEL BLADE
 ■ LAME ACIER INOXIDABLE
 ■ KILNGE AUS ROSTFREIEM
 ■ CUCHILLA de ACERO INOXIDABLE



ULTRA SHARP BLADE
 ■ LAME ULTRA AIGUISÉE
 ■ ULTRA-SHARPE KLINGE
 ■ CUCHILLA ULTRA AFILADA



FOR BOTH RIGHT- and LEFT- HANDED USERS
 ■ POUR UTILISATEURS GAUCHERS ET DROITIERS
 ■ FÜR RECHTS- und LINKSHÄNDER
 ■ PARA USUARIOS DIESTROS Y ZURDOS



PATENTED
 ■ BREVETÉ
 ■ PATENTIERT
 ■ PATENTADO



COMFORT GRIP
 ■ CONFORT GRIP
 ■ CONFORT GRIP
 ■ MANGO COMODO



PATENT PENDING
 ■ EN ATTENTE DE BREVET
 ■ ANGEWELDETES PATENT
 ■ PATENTE PENDIENTE



ACID AND ACETONE RESISTANT
 ■ RESISTANT À L'ACIDE ET À L'ACÉTONE
 ■ SAURE UND AZETON BESTÄNDIG
 ■ RESISTENTE AL ACIDO Y A LA ACETONA

Blade quantity in package

- Nombre de lames contenues dans l'emballage.
- Klingen Menge in Paket
- Cantidad de cuchillas por embalaje



25
mm

Extra Heavy-Duty Models

- **Modèles supplémentaires pour gros travaux**
- **Extra Stabile Modelle**
- **Modelos de trabajo pesado extra**



Featuring the 25mm blade, the extra heavy-duty cutters are most appropriate for professional work places.

- Avec la lame de 25 mm, les cutters supplémentaires pour les gros travaux sont plus appropriés pour les environnements de travail professionnels.
- Mit der 25-mm-Klinge sind die Cutter für schwere Arbeiten passend für professionelle Arbeitsplätze.
- Con una cuchilla de 25 mm, los cortadores de uso industrial son más apropiados para entornos de trabajo profesionales.

25mm
blade



X-Design, superior cutting force.

■ Conception-X, force de coupe supérieure. ■ X-Design, bessere Schneidekraft. ■ Diseño X, fuerza de corte superior.

XH-AL AUTO LOCK



XH-1



NH-1



Anti-Slip Elastomer handle.

■ Poignée en élastomère antidérapante.
■ Rutschfester Elastomergriff.
■ Mango de elastómero antideslizante.



H-1



HB/HBB/HSWB-1

6x12



With large cushion rubber.

- Avec un grand tampon en caoutchouc.
- Mit großer Unterplatte.
- Con almohadilla de caucho de gran tamaño.



HSW-1



HSWB-1/HB/HBB

6x12



Compact, with a new 25 mm SAW Blade.

- Compact, avec une nouvelle lame scie de 25 mm.
- Kompakt, mit einer neuen 25-mm-SÄGE-Klinge.
- Compacta, con una nueva cuchilla SAW de 25 mm.

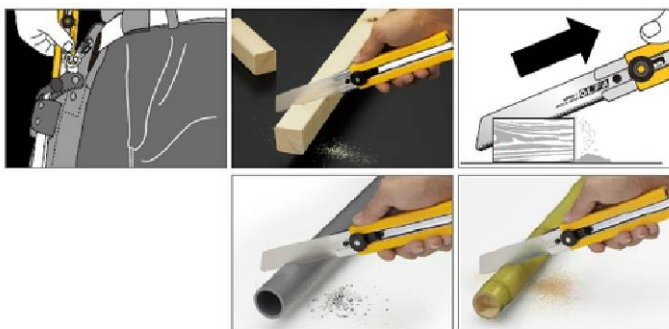
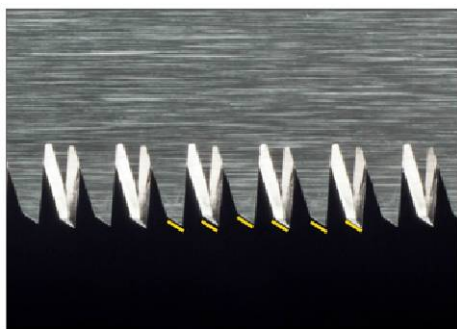

The HSWB-1 blade delivers the ultimate combination of extra-toughness and extra-sharpness. Impulse Hardening Process improves blade's life. Electroless Nickel Plating on blade is for added durability and corrosion resistance.

- La lame HSWB-1 offre la combinaison ultime d'extra solidité et d'affûtage. Le processus de durcissement à impulsion améliore la durée de vie de la lame. Le placage auto-catalytique au nickel sur la lame est pour une meilleure durabilité et résistance à la corrosion.
- Die HSWB-1-Klinge bietet die ideale Kombination von extra Härte und extra Schärfe. Impulshärtungsprozess verlängert die Lebensdauer der Klinge. Die stromlose Vernickelung der Klinge sorgt für zusätzliche Haltbarkeit und Korrosionsbeständigkeit.
- La cuchilla HSWB-1 ofrece la combinación perfecta de resistencia y afiladura adicionales. El proceso de endurecimiento del impulso mejora la vida útil de la cuchilla. El enchapado de níquel sin electricidad en la cuchilla está para aumentar la durabilidad y la resistencia a la corrosión.

High Value-Added Blades

■ Lames à forte valeur ajoutée ■ Extrem hochwertige Klingen ■ Cuchillas de alto valor añadido

LFB-5B



 x5

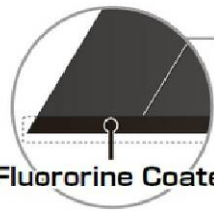

Fluorine Coated



The fluorine coated surface reduces cut resistance drastically while cutting through a cardboard.

- La surface en fluorure revêtu réduit la résistance de coupe de manière drastique pendant la coupe d'un carton.
- Die fluordbeschichtete Oberfläche reduziert den Schneidwiderstand beim Schneiden durch einen Karton drastisch.
- La superficie recubierta por fluorosis reduce la resistencia al corte drásticamente al cortar cartón.

LWB-3B



 x3

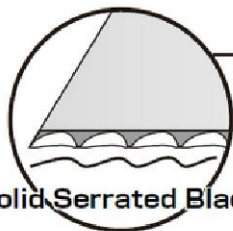

Solid Serrated Blade



The solid serrated blade outperforms the LB blade while cutting thick elastic materials such as thermal insulations, covering materials for piping and ropes.

- La lame ondulée solide surpasse la lame LB pendant la coupe de matériaux élastiques épais tels que les isolants thermiques, couvrant les matériaux pour la tuyauterie et les cordes.
- Die stabile gewellte Klinge übertrifft die LB-Klinge beim Schneiden dicker elastischer Materialien wie Thermoisolationen, Abdeckmaterialien für Rohre und Seilen.
- La sólida cuchilla ondulada supera el rendimiento de la cuchilla LB cuando se cortan materiales elásticos gruesos, como por ejemplo aislamientos térmicos, cubriendo materiales para tuberías y cuerdas.

18
mm

Heavy-Duty Models

■ **Modèles pour gros travaux** ■ **Stabile Modelle** ■ **Modelos de uso industrial**

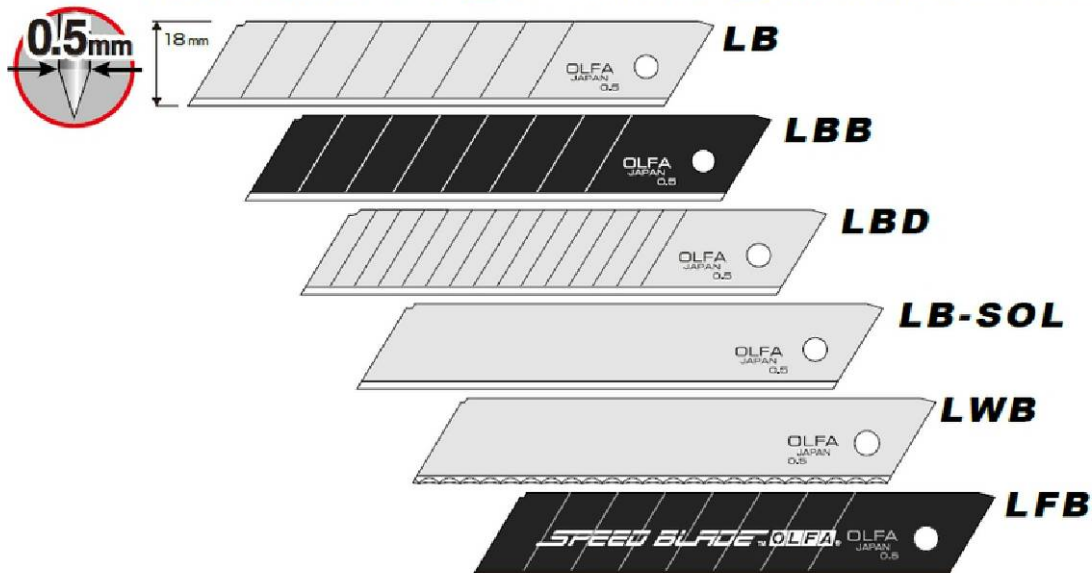

Featuring the 18mm blade, the heavy-duty handles are best suited for versatile cutting works.

- Avec la lame de 18 mm, les poignées robustes sont particulièrement adaptées pour les travaux de coupe polyvalents.
- Mit der 18-mm-Klinge sind die Griffe für schwere Arbeiten am besten für vielseitige Schneidearbeiten geeignet.
- Con una cuchilla de 18 mm, las asas de uso industrial son las mejores para las tareas de corte versátiles.

18mm
blade



X-design handles come with a built-in lanyard hole.
 Best suited to use at overhead locations with a safety lanyard.

- Les poignées de conception X sont fournies avec un passage de dragonne intégré.
 Optimisées pour une utilisation à des endroits en hauteur avec une lanière de sécurité.
- X-Design-Griffe verfügen über eine eingebaute Bandöse.
 Am besten geeignet für die Verwendung in Überkopfhaltungen mit einem Sicherheits-Halteband.
- Las asas con diseño en X manijas vienen con un orificio para cordón incorporado.
 Más adecuado para utilizar en ubicaciones por encima de la cabeza, con un cordón de seguridad.

L6-AL

-  LB/LBB/LBD/LB-SOL/LFB/LWB
-  6x20
-   



L-6

-  LB/LBB/LBD/LB-SOL/LFB/LWB
-  6x20
-   



X-Design, superior cutting force.

- Conception-X, force de coupe supérieure.
- X-Design, bessere Schneidekraft.
- Diseño X, fuerza de corte superior.

L5-AL AUTO LOCK

-   LB/LBB/LBD/LB-SOL/LFB/LWB
-  6x20



L-5

-   LB/LBB/LBD/LB-SOL/LFB/LWB
-  6x20



L-1

-   LB/LBB/LBD/LB-SOL/LFB/LWB
-  6x20



Best and longest selling model.

- Modèle le plus vendu depuis longtemps.
- Das beste und am längsten verkaufte Modell.
- El modelo de mayor y mejor venta.



L-2



LB/LBB/LBD/LB-SOL/LFB/LWB



6x20



With large cushion rubber.

- Avec un large tampon en caoutchouc.
- Mit großer Unterplatte.
- Con almohadilla de caucho de gran tamaño.

FL



LB/LBB/LB-SOL/LFB/LWB



6x20



Long blade sheath & manual lock.

- Gaine pour lame longue et verrouillage manuel.
- Lange Klingenschneide & manuelles Schloss.
- Estuche para cuchilla largo y bloqueo manual.

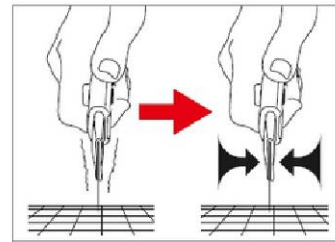

DL-1

AUTO LOCK



LB/LBB/LBD/LFB



6x20



With detachable blade snapper/disposal case.

- Avec casse-lame/boite de lames usagées.
- Mit Klingenschnapper/Entsorgungsbehälter.
- Con desglosador de cuchillas/estuche para descarte.

OL



LB/LBB/LBD/LB-SOL/LFB/LWB

6x20

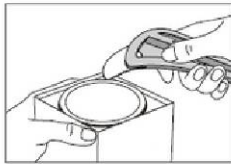

With extended blade channel & steel tucker.

- Avec conduit de lame prolongé et corps en acier.
- Mit erweitertem Klingenkanal & Stahl-Falzmesser.
- Con canal para cuchilla amplio y paleta de acero.

EXL



LB/LBB/LBD/LB-SOL/LFB/LWB

6x20



High cost-performance model.

- Modèle d'un excellent rapport qualité-prix.
- Preis-Leistungs-Modell.
- Modelo de alto rendimiento.

CL



LB/LBB/LBD/LB-SOL/LFB

6x20

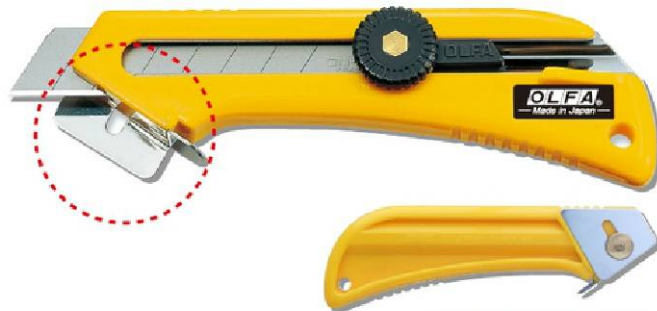

With spacer & staple remover.

- Avec entretoise et dégrafeur.
- Mit Abstandshalter & Enthefter.
- Con espaciador y extractor de grapas.



XL-2



LB/LBB/LBD/LB-SOL/LFB/LWB



6x10



For jobs requiring extra reach.

- Pour des travaux nécessitant une grande flexibilité.
- Für Arbeiten mit einem größeren Wirkungsbereich.
- Para aquellos trabajos que requieran de mayor alcance.



CMP-2



LB/LBB/LBD/LFB



5x10



Circle cutter for dia. 7-30cm.

- Cutter circulaire pour diamètre de 7 à 30 cm.
- Kreismesser für Durchmesser. 7-30 cm.
- Cortador circular para diámetros de 7 a 30 cm.



ML



LB/LBB/LB-SOL/LFB/LWB



6x20



With metal handle.

- Avec poignée en métal.
- Mit Metallgriff.
- Con mango metálico.

SL-1



LB/LBB/LB-SOL/LFB/LWB

6x20



With unique tractor locking system.

- Avec système de verrouillage par traction unique.
- Mit einzigartigem Schleppverriegelungssystem.
- Con sistema de bloqueo tractor único.

PL-1



LB/LBB/LBD/LB-SOL/LFB/LWB

6x20



LB x3



Auto-loading up to 6 blades.

- Chargement automatique jusqu'à 6 lames.
- Automatisches Laden mit bis zu 6 Klingen.
- Carga automática de hasta 6 cuchillas.



L-3



LB/LBB/LBD/LFB

6x20



For both tough & fine cutting.

- Pour une découpe à la fois fine et difficile.
- Sowohl für grobes als auch für feines Schneiden.
- Tanto para cortes precisos como para cortes difíciles.



Anti-Slip elastomer handle.

- Poignée en élastomère antidérapante.
- Rutschfester Elastomergriff.
- Mango de elastómero antideslizante.

NL-AL

-  
-  LB/LBB/LBD/LB-SOL/LFB/LWB
-  6x20
-   



NOL-1

-  
-  LB/LBB/LBD/LB-SOL/LFB/LWB
-  6x20
-   



Versatile models in ergonomic design.

- Modèle polyvalent à la conception ergonomique.
- Vielfältiges Modell im ergonomischen Design.
- Modelo versátil de diseño ergonómico.

BN-AL

-  
-  LB/LBB/LBD/LB-SOL/LFB/LWB
-  6x20
- 



BN-L

-  
-  LB/LBB/LBD/LB-SOL/LFB/LWB
-  6x20
- 



9
mm

Standard-Duty Models

■ **Modèles standards** ■ **Standard Modelle** ■ **Modelos estándar**

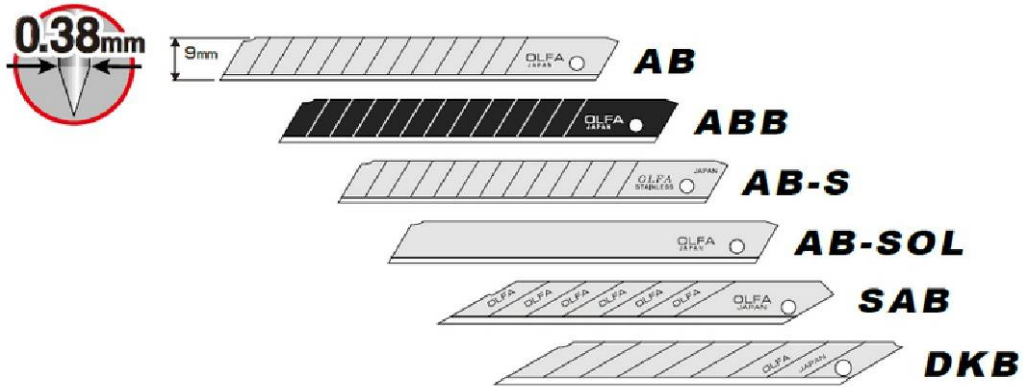

Featuring the 9mm blade, standard-duty cutters are better-suited for precise cutting works as well as general purposes.

- Avec la lame de 9 mm, les cutters standards sont mieux adaptés pour assurer la précision de coupe ainsi que des utilisations générales.
- Mit der 9-mm-Klinge sind Cutter für Standardarbeiten besser geeignet für präzise Schneidearbeiten sowie für allgemeine Aufgaben.
- Con una cuchilla de 9 mm, los cortadores para tareas estándar son más adecuados para trabajos de corte precisión así como para fines generales.



A-1

AUTO LOCK



AB/ABB/AB-S/SAB/DKB/AB-SOL



6x40



Evolutional Classic A, with blade snapper/clip.

- Evolutional Classic A, avec casse-lame/clip.
- Evolutionär Klassik A, mit Klingenschnapper/Clip.
- Clásico evolutivo A con partidor/clip de cuchilla.

XA-1

AUTO LOCK



AB/ABB/AB-S/AB-SOL



6x40



X-Design, superior cutting force.

- Conception-X, force de coupe supérieure.
- X-Design, bessere Schneidkraft.
- Diseño X, fuerza de corte superior.

A-5

AUTO LOCK



AB/ABB/AB-S/AB-SOL



6x40



With original one-way locking system.

- Avec système de verrouillage à sens unique.
- Mit einseitigem Verriegelungssystem.
- Con sistema de bloqueo unidireccional.

NA-1

AUTO LOCK



AB/ABB/AB-S/AB-SOL



6x40





Anti-Slip Elastomer handle.

- Poignée élastomère antidérapante.
- Rutschfester Elastomergriff.
- Mango de elastómero antideslizante.

300

-   AB/ABB/AB-S/AB-SOL
-  6x20

With screw locking system.

-  Avec système de verrouillage à vis.
-  Mit Schraubenverriegelungssystem.
-  Con sistema de bloqueo de tornillo.





SAC-1



-   SAB/DKB
-  6x40



With 30-degree angle blade.

-  Avec lame d'angle à 30 degrés.
-  Mit 30 Grad Winkelklinge.
-  Con cuchilla en ángulo de 30 grados.



All stainless steel models.

-  Tous les modèles en acier inoxydable.
-  Modell komplett aus Edelstahl.
-  Todos los modelos son de acero inoxidable.

SVR-1

-   AB-S/AB/ABB/AB-SOL
-  6x40



SVR-2



-   AB-S/AB/ABB/AB-SOL
-  6x40

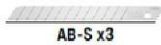

A-2



Basic model with rubber grip.

- Modèle de base avec poignée en caoutchouc.
- Grundmodell mit Gummigriff.
- Modelo básico con mango de caucho.

A-3



Two-way cutter.

- Cutter double-sens.
- Zweiseitiges Messer.
- Cuchilla bidireccional.



DA-1



With detachable blade snapper/disposal case.

- Avec casse-lame/boîte de lames usagées.
- Mit Klingenschnapper/Entsorgungsbehälter.
- Con desglosador de cuchillas/estuche para descarte.

PA-2

AUTO
LOCK

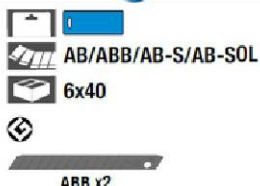

EXCEL-BLACK
ULTRA SHARP BLADES



Auto-loading up to 5 blades.

- Chargement automatique jusqu'à 5 lames.
- Automatisches Laden mit bis zu 5 Klingen.
- Carga automática de hasta 5 cuchillas.

SPC-1/40

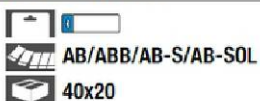

High cost-performance model.

- Modèle d'un excellent rapport qualité-prix.
- Preis-Leistungs-Modell.
- Modelo de alto rendimiento.



180 Black

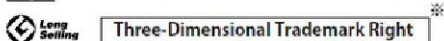
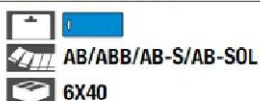

Metal handle with blade snapper/clip.

- Poignée métallique avec casse-lame/clip.
- Metallgriff mit Klingenschnapper/Clip.
- Mango metálico con desglosador de cuchillas/clip.

180-BT/36

36X10



S

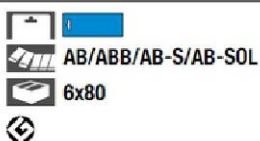

Slim metal body with blade snapper/clip.

- Corps en métal allégé avec casse-lame/clip.
- Schlanker Metallkörper mit Klingenschnapper/Clip.
- Cuerpo metálico fino con desglosador de cuchilla/clip.



S/20

20x30



12.5
mm

Medium-Sized Models



■ **Modèles médium** ■ **Medium Modelle** ■ **Modelos medianos**

The 0.45mm-thick 12.5mm MTB blade bridges the gap between the 9mm blade and the 18mm blade.

- La lame de 0,45 mm d'épaisseur 12,5 mm MTB est intermédiaire entre la lame de 9 mm et la lame de 18 mm.
- Die 0,45 mm dicke 12,5-mm-MTB-Klinge schließt die Lücke zwischen der 9-mm-Klinge und der 18-mm-Klinge.
- La cuchilla MTB de 0,45 mm de grosor y de 12,5 mm acorta la distancia entre la cuchilla de 9 mm y la de 18 mm.



MT-1

AUTO
LOCK



The most versatile cutter.

- Le cutter le plus polyvalent.
- Das vielseitigste Messer.
- El cortador más versátil.



The thin 0.25mm-thick Ultra Sharp Black Blade leaves a beautiful cut surface.

- La lame noire affûtée ultra épaisse de 0,25 mm laisse une belle surface de coupe.
- Die dünne 0,25 mm dicke Ultra Sharp Black-Klinge hinterlässt eine wunderschöne Schnittoberfläche.
- La cuchilla Ultra Sharp Black fina de 0,25 mm de grosor deja una bonita superficie de corte.



FWP-1

AUTO
LOCK



EXCELBLACK
ULTRA SHARP BLADES



Thinner blade wallcovering cutter.

- Cutter à lame plus fine pour revêtement mural.
- Dünneres Klingen-Wandverkleidungsmesser.
- Cortador fino con cuchilla para revestimiento de pared.



Blade Disposal Cases

■ **Boîte de lames usagées.** ■ **Entsorgungsbehälter** ■ **Estuche para descarte.**

Keeping the blade edge sharp all the time leads to safety. OLFA Blade Disposal Cases help users snap off a blade and store used blade segments safely until disposing of them.

- Garder le bord de la lame constamment affûté entraîne la sécurité. Les boîtes de lames usagées OLFA aident les utilisateurs à casser une lame et à ranger en toute sécurité des morceaux de lame usées jusqu'au rebut de ces derniers.
- Das ständige Scherhalten der Klingenschneide führt zu mehr Sicherheit. OLFA Klinsen-Entsorgungsbehälter helfen Verwendern, eine Klinge abzubringen und gebrauchte Klingensegmente sicher aufzubewahren, bis sie entsorgt werden.
- Mantener el filo afilado todo el tiempo para aumentar la seguridad. Los estuches para el desecho de cuchillas OLFA ayuda a los usuarios a desglosar una cuchilla y almacenar los segmentos usados de la cuchilla de forma segura hasta que se deshaga de ellos.



**For Safety,
Environment &
Convenience.**

For safety, environment & convenience.
For getting a fresh cutting point comfortably & safely.

- Par mesure de sécurité, pour des raisons environnementales et de convenance. Pour obtenir confortablement et en toute sécurité des points de coupe nets.
- Für Sicherheit, Umwelt & Komfort. Für das bequeme & sichere Erlangen eines frischen Schneidepunktes.
- Por motivos de seguridad, medioambiente y conveniencia. Para obtener un punto de corte preciso, cómodo y seguro.

DC-1

 10x20



DC-2

 Paper Box
 6x20



DC-3

 10x20



DC-4

 Paper Box
 6x40



DC-5

 
 6x20



Blade Disposal Holster

- Etui pour lames usagées
- Klingensorgungshalterung
- Portador de hojas desechables

※ The DC-5 is NOT compatible with: All the 25mm extra heavy-duty models, 18mm heavy-duty models: CL, KL, PL-1, SL-1, CMP-2, and 9mm standard-duty models: PA-2, SPC-1, ES-1/green.

※ Le DC-5 n'est PAS compatible avec : Tous les modèles supplémentaires pour gros travaux de 25 mm, modèles de 18 mm pour gros travaux : CL, KL, PL-1, SL-1, CMP-2 et les modèles standard de 9 mm : PA-2, SPC-1, ES-1/vert.

※ Das DC-5 ist NICHT kompatibel mit: Allen 25-mm-Modellen für extra schwere Arbeiten, 18-mm-Modellen für schwere Arbeiten: CL, KL, PL-1, SL-1, CMP-2 und 9-mm-Modellen für Standardarbeiten: PA-2, SPC-1, ES-1/grün.

※ El DC-5 NO es compatible con: Todos los modelos de uso industrial extra de 25 mm, modelos de uso industrial de 18 mm: CL, KL, PL-1, SL-1, CMP-2 y los modelos de uso estándar de 9 mm: PA-2, SPC-1, ES-1/verde.

DC-6

  paperworld & creativeworld
 5x10
 



Complete Desktop Blade Disposal system

- Solution complète de bureau pour rangement de lames.
- Komplettes arbeitsoberflächenklingensorgungssystem.
- Sistema completo de desecho de cuchillas para escritorios.

※ The DC-6 is NOT compatible with: All the 25mm extra heavy-duty models, 18mm heavy-duty models: CL, KL, OL, PL-1, SL-1, CMP-2, LL, ML, and 9mm standard-duty models: PA-2, SPC-1, ES-1/green.

※ Le DC-6 n'est PAS compatible avec : Tous les modèles supplémentaires pour les gros travaux de 25 mm, modèles pour gros travaux de 18 mm : CL, KL, OL, PL-1, SL-1, CMP-2, LL, ML et les modèles standard de 9 mm : PA-2, SPC-1, ES-1/vert.

※ Das DC-6 ist NICHT kompatibel mit: Allen 25-mm-Modellen für extra schwere Arbeiten, 18-mm-Modellen für schwere Arbeiten: CL, KL, OL, PL-1, SL-1, CMP-2, LL, ML und 9 mm Modellen für Standardarbeiten: PA-2, SPC-1, ES-1/grün.

※ El DC-6 NO es compatible con: Todos los modelos de uso industrial extra de 25 mm, modelos de uso industrial de 18 mm: CL, KL, OL, PL-1, SL-1, CMP-2, LL, ML y modelos de uso estándar de 9 mm: PA-2, SPC-1, ES-1/verde.



OLFA green™

■ Série écologique ■ Öko-Reihe ■ Serie ecológica



Environment-Friendly, cutters made from recycled material.
Equal durability and blade sharpness with regular version respectively.

- Respectueux de l'environnement, cutters fabriqués à partir de matériaux recyclés. Durabilité et affutage de la lame équivalents à la version normale.
- Umweltfreundlich, Messer aus recyceltem Material. Gleiche Haltbarkeit und Klingenschärfe mit der regulären Version.
- Cuchillas ecológicas hechas de materiales reciclados. La misma durabilidad y afilado que la versión regular.

L-1/green



LB/LBB/LBD/LB-SOL/LFB/LWB

6x20



Green version of the best seller.

- Version écologique du produit phare.
- Öko-Version des Bestsellers.
- Versión ecológica del más vendido.

SK-7/green



SKB-7

6x20

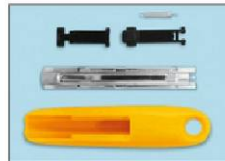

Compact safety cutter.

- Cutter de sécurité compact.
- Kompaktes Sicherheitsmesser.
- Cortador de seguridad compacto.

ES-1/green



AB/ABB/AB-S/AB-SOL

6x40



Enables to disassemble into 5 parts for recycling.

- Permet de démonter en 5 parties pour le recyclage.
- Kann zum Recyceln in 5 Teile auseinandergenommen werden.
- Permite su desmantelamiento en 5 partes para su reciclaje.

SK-4/green



SKB-2/RSKB-2/HOB-2

6x20



Green version of the popular safety cutter.

- Version écologique du cutter de sécurité populaire.
- Öko-Version des beliebten Sicherheitsmessers.
- Versión ecológica de la popular cuchilla de seguridad.

Scissors

■ Ciseaux ■ Scheren ■ Tijeras

OLFA scissors with straight edge, with serrated edge for versatile work.

- Ciseaux OLFA avec lame plate, avec lame dentée pour le travail polyvalent.
- OLFA Scheren mit gerader Schneide, mit gezahnter Schneide für vielseitige Arbeiten.
- Las tijeras OLFA con filo recto, con filo en sierra para trabajo versátil.



SCS-1



Tough serrated scissors, Small.

- Ciseaux dentés résistants, petit modèle.
- Grob gezackte Scheren, Klein.
- Tijeras dentadas resistentes, Pequeñas.

SCS-2

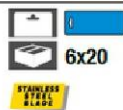

Tough serrated scissors, Large.

- Ciseaux dentés résistants, grand modèle.
- Grob gezackte Scheren, Groß.
- Tijeras dentadas resistentes, Grandes.

SCS-3



High cost-performance model.

- Modèle d'un excellent rapport qualité-prix.
- Preis-Leistungs-Modell.
- Modelo de alto rendimiento.

SCS-4



For more precise work.

- Pour un travail plus précis
- Für genaueres Arbeiten
- Para un trabajo más preciso



SCS-2



SCS-3



SCS-4

Safety Models

■ **Modèles de sécurité** ■ **Sicherheits-Modelle** ■ **Modelos de seguridad**

Featuring Quick Blade Change, every OLFA Safety Knife makes a contribution to safe working conditions.

- Avec le changement de lame rapide, chaque couteau de sécurité OLFA contribue à des conditions de travail en toute sécurité.
- Mit dem schnellen Klängenwechsel liefert jedes OLFA Sicherheitsmesser einen Beitrag zu sicheren Arbeitsbedingungen.
- Con la función de cambio rápido de cuchilla, cada cuchillo de seguridad OLFA contribuye a unas condiciones de trabajo seguras.



SAFETY TYPE.1

Spring-activated blade, that automatically retracts after cutting and when not in use, reduces injuries in the workplace.

- La lame activée par un ressort, qui se rétracte automatiquement après la coupe lorsque vous ne vous en servez pas, réduit les risques de blessures sur le lieu de travail.
- Federaktivierte Klinge, die sich nach dem Schneiden und bei Nicht-Verwendung automatisch zurückzieht und Verletzungen am Arbeitsplatz reduziert.
- Cuchilla activada por muelle, que se retrae automáticamente tras el corte y cuando no está en uso, reduciendo las lesiones en el lugar de trabajo.

1. Push the blade out

- Poussez la lame
- Drücken Sie die Klinge heraus
- Empuje la cuchilla hacia fuera

2. Release thumb from the slider

- Relâchez le pouce du curseur
- Nehmen Sie den Daumen vom Schieber
- Suelte el pulgar del pulsador

3. Auto-retraction

- Auto-rétraction
- Auto-Rückzug
- Retracción automática

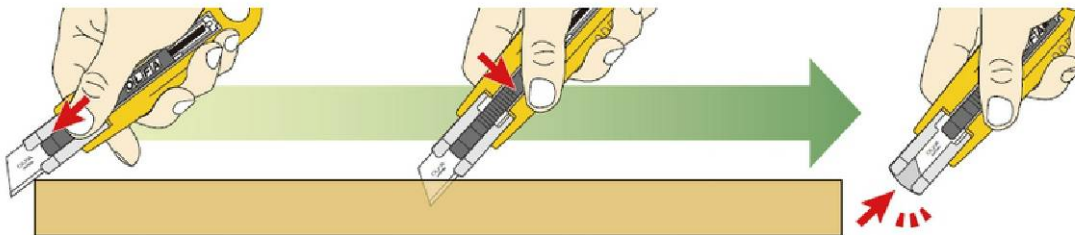

SK-4 SAFETY TYPE.1

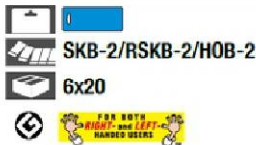

The best selling safety cutter.

- Le cutter de sécurité le plus vendu.
- Das meistverkaufte Sicherheitsmesser.
- El cortador de seguridad más vendido.



SK-5 SAFETY TYPE.1



Anti-Slip Elastomer handle.

- Poignée en élastomère antidérapante.
- Rutschfester Elastomergriff.
- Mango de elastómero antideslizante.



SK-9 SAFETY TYPE.1



With metal tape slitter.

- Avec découpeuse à ruban métallique.
- Mit Metall-Bandlängsschneider.
- Con cortador de cinta de metal.



SK-7 SAFETY TYPE.1



Compact safety cutter.

- Cutter de sécurité compact.
- Kompaktes Sicherheitsmesser.
- Cortador de seguridad compacto.



SAFETY TYPE.2

The built-in safety guard gets activated once the cut begins and automatically covers the blade after cutting.

- Le dispositif de sécurité intégré s'active une fois que la coupe commence et couvre automatiquement la lame après la coupe.
- Der eingebaute Sicherheitsschutz wird aktiviert, wenn der Schnitt beginnt und bedeckt die Klinge nach dem Schneiden automatisch.
- La protección de seguridad integrada se activa al comenzar el corte, y tras finalizarlo cubre automáticamente la cuchilla.



SK-6



Automatic protection guard.

- Carter de protection automatique.
- Automatische Schutzeinrichtung.
- Cubierta de protección automática.

SAFETY TYPE.3

Blade automatically retracts the instant it loses contact with the material being cut, even with the engaged blade slider.

- La lame se rétracte automatiquement à l'instant où elle perd contact avec le matériau coupé, même avec le curseur de la lame engagé.
- Die Klinge zieht sich automatisch in dem Moment zurück, wenn sie Kontakt mit dem zu schneidenden Material verliert, auch mit aktiviertem Klingenschieber.
- La cuchilla se retrae automáticamente en cuanto deja de estar en contacto con el material que está siendo cortado, incluso con el pulsador de la cuchilla accionado.



The "click" sound means the safety function is activated. Anti-Slip Rubber Grip for perfectly controlled cutting operation. Durable Aluminium Die-Casting head for heavy use.

- Le son « clic » signifie que la fonction de sécurité est activée. La poignée en caoutchouc antidérapant pour des opérations de coupe parfaitement contrôlées. Tête en moulage sous pression en aluminium durable pour utilisation intensive.
- Das „Klick“-Geräusch bedeutet, dass die Sicherheitsfunktion aktiviert ist. Rutschsicherer Gummigriff für perfekt kontrollierten Schnittbetrieb. Haltbarer Aluminium-Druckgusskopf für schwere Arbeiten.
- El "clic" que se oye quiere decir que la función de seguridad está activada. Mango de caucho antideslizante para un corte perfectamente controlado. Cabezal a presión de aluminio duradero para usos industriales.

SK-8



Automatic self-retracting system.

- Système auto-rétractable automatique.
- Automatisches selbsteinziehendes System.
- Sistema auto-retráctil automático.

SAFETY TYPE.4

SK-10



Stretch Wrap Cutter

- Cutter extensible pour emballage
- Streckverpackungsmesser
- Cutter para flejes y films

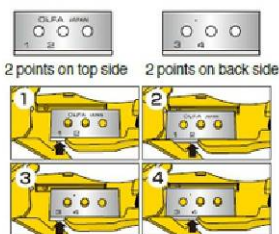

Safety Models Industrial Package

- **Emballage industriel pour les modèles de sécurité**
- **Sicherheitsmodelle Industriepaket**
- **Paquete industrial de modelos de seguridad**



Cost saving industrial package

- Emballage Industriel économique
- Kostensparendes Industriepaket
- Paquete Industrial de ahorro de costes



SK-4/24

SKB-2/RSKB-2/HOB-2

24x6



The world's most popular and best selling safety knife.

- Le couteau de sécurité le mieux vendu au monde et le plus populaire.
- Das weltweit beliebteste und meistverkaufte Sicherheitsmesser.
- El cuchillo de seguridad más vendido y más popular del mundo.

SK-7/24

SKB-7

24x12



This compact safety knife is small but for real.

An ECO MARK product accredited by the Japan Environmental Association.

- Ce couteau de sécurité compact est réellement petit.
Un produit ECO MARK accrédité par l'association de l'environnement du Japon.
- Dieses kompakte Sicherheitsmesser ist klein, aber beachtlich.
Ein ECO MARK Produkt, anerkannt von der Japan Environmental Association.
- Este cuchillo de seguridad compacto es pequeño pero efectivo.
Un producto ECO MARK acreditado por la Asociación Japonesa del Medio Ambiente.

SK-8/24

SKB-8

24x6



Extra protection safety knife.

Blade automatically retracts after cutting even if the blade slider is engaged.

- Protection supplémentaire du couteau de sécurité.
La lame se rétracte automatiquement après la coupe même si le curseur de la lame est engagé.
- Sicherheitsmesser mit extra Schutz. Die Klinge zieht sich nach dem Schneiden automatisch zurück, auch wenn der Klingenschieber aktiviert ist.
- Cuchillo de seguridad para una protección extra. La cuchilla se repliega automáticamente después de un corte incluso si el deslizador de la cuchilla está enganchado.

SK-9/32

SKB-2/RSKB-2/HOB-2

32x4



Safety knife with built-in heat-hardened tape slitter.

- Couteau de sécurité avec découpeuse à ruban thermique durci intégrée.
- Sicherheitsmesser mit eingebautem hitzgehärteten Klebebandschneider.
- Cuchillo de seguridad con un cortador de cinta endurecido por el calor incorporado.

SK-10/24

SKB-10

24x8



Concealed blade Stretch Wrap cutter. Aceton and impact resistant handle.

- Cutter à lame extensible cachée. Aceton et poignée résistante aux chocs.
- Cutter für Streckfolie mit verborgener Klinge. Aceton- und stoßfester Griff.
- Cortador Stretch Wrap con cuchilla escondida. Aceton y asa resistente a los impactos.

SAFETY FIRST

Scrapers

■ **Grattoirs** ■ **Schabmesser** ■ **Raspadores**

From handy type to heavy duty type, OLFA scrapers accommodate removing, scraping and cutting works.

- De type à portée de main à type robuste, les racleurs OLFA s'adaptent au retrait, au raclement et aux travaux de coupe.
- Vom praktischen Typ bis zum Typ für schwere Arbeiten, OLFA Schaber decken Arbeiten wie Entfernen, Schaben und Schneiden ab.
- Desde tipo práctico a tipo de uso industrial, los raspadores OLFA acomodan las tareas de extracción, raspado y corte.



200mm long

300mm long

600mm long

Compact model

Arc blade



The professional XSR Scraper Series feature a hammerable grip end and a heavy-duty 0.8mm-thick blade as standard equipment.

- La série de racleur XSR professionnel offre une extrémité de poignée de martelable et une lame épaisse robuste 0.8 mm comme équipement standard.
- Die professionelle XSR Schaberreihe hat ein hämmerbares Griffende und eine 0.8 mm dicke Klinge für schwere Arbeiten als Standardausrüstung.
- La serie de raspadores profesionales XSR ofrecen una toma en el extremo que se puede utilizar con un martillo y una cuchilla de uso industrial de 0.8 mm de grosor como equipo estándar.

XSR-200



BS08/BS/BSF/LB

5x6



Scraper with 200mm-long X-design handle

- Racleur avec poignée de conception X longue de 200 mm
- Schaber mit 200 mm langem X-Design Griff
- Rascador con un mango con diseño de X de una longitud de 200 mm.



XSR-300



BS08/BS/BSF/LB

5x6



Scraper with 300mm-long X-design handle

- Racleur avec poignée de conception X longue de 300 mm
- Schaber mit 300 mm langem X-Design Griff
- Rascador con un mango con diseño de X de una longitud de 300 mm.



XSR-600



BS08/BS/BSF/LB

5x6



Scraper with 600mm-long X-design handle

- Racleur avec poignée de conception X longue de 600 mm
- Schaber mit 600 mm langem X-Design Griff
- Rascador con un mango con diseño de X de una longitud de 600 mm.



Awarded as a great new product at Japan DIY Homecenter Show 2014.

- Récompensé en tant que grand nouveau produit au Japan DIY Homecenter Show 2014.
- Ausgezeichnet als großartiges neues Produkt bei der Japan DIY Homecenter Show 2014.
- Premiado como un nuevo gran producto en la feria DIY Homecenter de 2014 en Japón.

Handy scrapers with unique multi-edged arc blade.

- Grattoir maniable avec lame en arc multi-tranchants.
- Handliches Schabmesser mit mehrschneidiger Bogenklinge
- Raspador práctico con cuchilla de arco de varios filos.

T-45



Blade width: 45mm

- Largeur de la lame: 45 mm
- Klingenbreite: 45 mm
- Anchura de la cuchilla: 45 mm

BTC-1

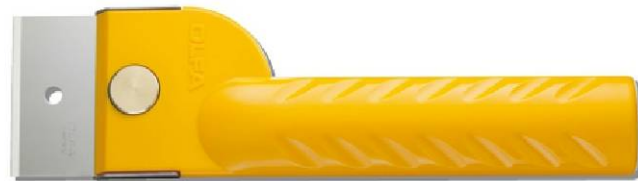

Knife-edged scraper for scraping glass & cutting leather.

- Grattoir à bord tranchant pour gratter le verre et découper le cuir.
- Messerschneiden-Schabmesser zum Schaben von Glas & Schneiden von Leder.
- Raspador con filos de cortador para raspar cristal y cortar cuero.

Compact scrapers for cleaning floor & glass top oven.

- Grattoirs compacts pour le nettoyage des sols et des fours à porte en verre.
- Kompakt-Schabmesser zum Reinigen des Bodens & der Ofenglasdecke.
- Raspadores compactos para la limpieza de suelos y cubiertas de cristal de hornos.

SCR-S



Blade width: 25mm

- Largeur de la lame: 25mm
- Klingenbreite: 25mm
- Anchura de la cuchilla: 25mm

SCR-M



Blade width: 43mm

- Largeur de la lame: 43mm
- Klingenbreite: 43mm
- Anchura de la cuchilla: 43mm

SCR-L



Blade width: 60mm

- Largeur de la lame: 60mm
- Klingenbreite: 60mm
- Anchura de la cuchilla: 60mm



Rotary Cutters

■ **Cutters rotatifs**
■ **Rundmesser**
■ **Cortadores rotativos**

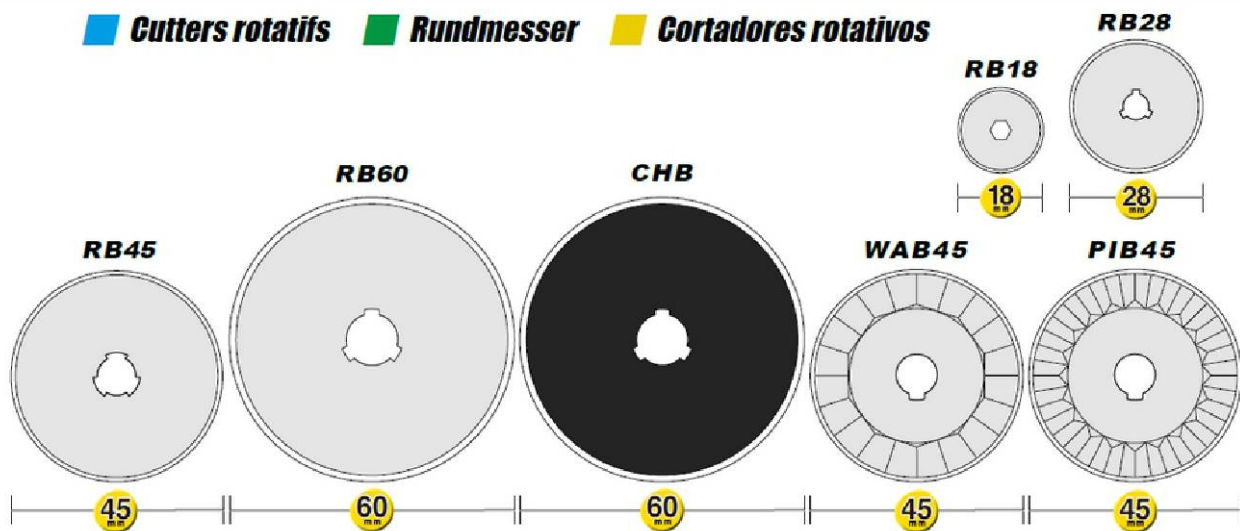

The OLFA's invention of the Rotary Cutter in 1979 totally changed the world of quilting techniques, and delivered extraordinary convenience no one could imagine back then.

- L'invention du cutter rotatif d'OLFA en 1979 a totalement modifié le monde des techniques de piquage et livré une commodité extraordinaire que personne ne pouvait imaginer à l'époque.
- OLFA's Erfindung des Rotationscutters 1979 veränderte die Welt der Quiltingtechniken komplett und bietet außergewöhnlichen Komfort, den sich bis dahin niemand vorstellen konnte.
- La invención del cortador rotativo de OLFA en 1979 cambió totalmente el mundo de las técnicas de acolchado y proporcionó una conveniencia extraordinaria que nadie podía imaginarse entonces.



18mm ϕ
28mm ϕ
45mm ϕ
60mm ϕ

Chenille Cutter
Pinking Blade
Wave Blade

Loved by many quilters and craft enthusiasts in the world since the launch in 1979. Simple and basic functions assist user's creativity for long years.

- Apprécie par de nombreux artisans et amateurs de bricolage dans le monde depuis sa mise sur le marché en 1979. Ses fonctions de base simples aident à la créativité de son utilisateur depuis de longues années.
- Von vielen Quilt-Herstellern und Handwerksbegeisterten weltweit seit der Einführung 1979 geliebt. Einfache und grundlegende Funktionen unterstützen über viele Jahre die Kreativität des Benutzers.
- Adorado por muchos entusiastas de la artesanía y costura de todo el mundo desde su lanzamiento en 1979. Funciones simples y básicas para ayudar durante muchos años a la creatividad del usuario.

RTY-3/G



Largest model with powerful blade.

- Modèle le plus grand avec lame puissante.
- Größtes Modell mit kraftvoller Klinge.
- El mayor modelo con una poderosa cuchilla.

RTY-2/G



Basic model for wide applications.

- Modèle de base pour de multiples applications.
- Grundmodell für umfangreiche Anwendungen.
- Modelo básico para numerosas aplicaciones.

RTY-1/G



Small model with 28 mm blade.

- Petit modèle avec lame de 28 mm.
- Kleines Modell mit 28 mm Klinge.
- Modelo reducido con cuchilla de 28 mm.

RTY-4



For detailed works.

- Pour travaux détaillés.
- Für detaillierte Arbeiten.
- Para trabajos detallados.

RTY-2/C



High cost-performance rotary cutter with 45 mm blade featured Quick Blade Replacement.

- Un cutter rotatif d'excellent rapport qualité-prix avec lame de 45 mm qui comprend le remplacement de lame rapide.
- Der hochwertige Rotationscutter mit 45-mm-Klinge bietet schnellen Klinsenwechsel.
- Cortador rotativo de alto rendimiento con una cuchilla de 45 mm con reemplazo de cuchilla rápido.



Safety locking system.

Designed for reducing hand fatigue and potential injuries at working place.

- La série DX dispose d'un système de verrouillage de sécurité.
Conçu pour réduire la fatigue manuelle et les blessures potentielles sur le lieu de travail.
- Die DX-Reihe bietet ein Sicherheitsverriegelungssystem.
Entwickelt, um die Handermüdung und potentielle Verletzungen am Arbeitsplatz zu verringern.
- La serie DX posee un sistema de bloqueo de seguridad.
Diseñado para reducir el cansancio de la mano y posibles lesiones durante el trabajo.

RTY-3/DX



Large model with 60mm blade.

- Grand modèle avec lame de 60 mm.
- Großes Modell mit 60 mm Klinge.
- Modelo superior con cuchilla de 60 mm.



RTY-2/DX



With 45 mm blade, can accommodate decorative blades as well.

- Avec une lame de 45 mm, peut s'adapter aux lames décoratives.
- Mit 45 mm Klinge, kann dekorative Klinsen unterbringen.
- Con cuchilla de 45 mm, puede acomodar cuchillas decorativas.



The combination of quick blade changing system, split blade cover and ergonomic comfort Grip.

- Combinaison d'un système de changement de lame rapide, d'un étui pour lame divisée et d'une poignée ergonomique confortable.
- Die Kombination aus schnellem Klängen-Wechselsystem, Schnappmesser-Abdeckung und ergonomischen Komfortgriff.
- Combinación del sistema de recambio rápido de cuchilla, cubierta de cuchilla desglosable y mango ergonómico cómodo.



RTY-3/NS



Large model with 60 mm blade.

- Grand modèle avec lame de 60 mm.
- Großes Modell mit 60 mm Klinge.
- Modelo superior con cuchilla de 60 mm.

RTY-2/NS



Perfect for multiple use.

- Idéal pour un usage multiple.
- Perfekt für Mehrfachnutzung.
- Perfecto para diversos usos.

CMP-3



Cutting fabrics in circle in dia. 4-22mm

- Découpe de tissus en cercle de diamètre de 4 à 22 mm
- Schneidet Stoffe im Kreis im Durchm. 4-22 mm
- Corta telas en círculos de un diámetro de 4-22 mm



CHN-1



Chenille cutter with 4 channel guides. With carrying case.

- Cutter chenille avec 4 guides de conduit. Avec étui de transport.
- Chenille-Messer mit 4 Führungskanälen. Mit Tragetasche.
- Cortador de felpa con 4 guías de canal. Con funda para transporte.



Quilt Rulers

■ Règles de matelassage ■ Quilt-Lineale ■ Reglas de costura



Non-slip, frosted surface acrylic rulers. Legible grid lines on both light and dark colored fabrics.

- Règle en acrylique avec surface dépolie antidérapante. Lignes de la grille lisibles à la fois sur les tissus de couleur claire et foncée.
- Rutschfest, mattierte Oberfläche Acryllineale. Lesbare Gitterlinien sowohl auf hellen als auch auf dunkelfarbigen Stoffen.
- Reglas acrílicas de superficie mate anti deslizantes. Líneas de cuadrícula legibles en telas con colores oscuros y claros.

Scale
cm

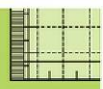

shrink wrap

- ① MQR-30x30 30cm x 30cm 6x8 PAT
- ② MQR-15x30 15cm x 30cm 6x8 PAT
- ③ MQR-15x60 15cm x 60cm 6x8 PAT

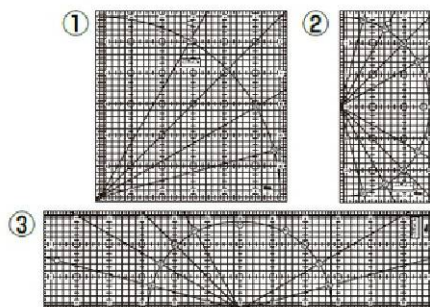

Scale
inch

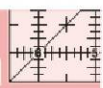

shrink wrap

※ ■ 6.5" TRIANGLE DROIT ■ 6.5" RECHTES DREIECK ■ 6.5" TRIÁNGULO DERECHO

- ① QR-1x12 1 1/4" x 12.5" 12x20
- ② QR-2S 2.5" x 2.5" 12x20
- ③ QR-4S 4.5" x 4.5" 6x10
- ④ QR-6S 6.5" x 6.5" 6x10
- ⑤ QR-9S 9.5" x 9.5" 6x8
- ⑥ QR-12S 12.5" x 12.5" 6x4
- ⑦ QR-16S 16.5" x 16.5" 6x2
- ⑧ QR-6x12 6" x 12" 6x8 PAT
- ⑨ QR-6x24 6" x 24" 6x4 PAT

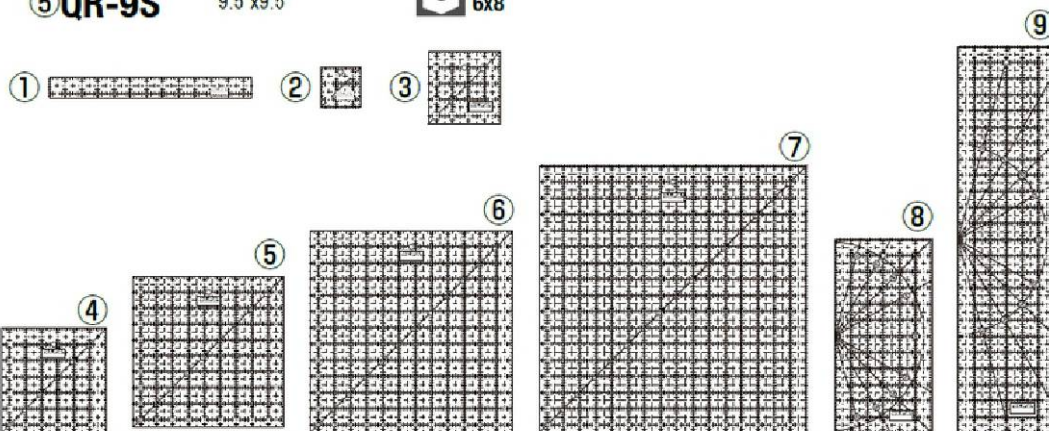

Other Purpose-Made Hand Tools

- **Autres outils manuels pour usage spécifique**
- **Andere speziell angefertigte Handwerkzeuge**
- **Otras herramientas manuales hechas a propósito**

The wide array of cutting tools best suited for every idea, every cutting material, and every working environment.

- Le large éventail d'outils de coupe les mieux adaptés pour chaque idée, chaque matériau de coupe, et chaque environnement de travail de coupe.
- Das umfangreiche Sortiment an Schneidwerkzeugen, die am besten für jede Idee, jedes Schneidmaterial und jede Arbeitsumgebung passen.
- La amplia gama de las herramientas de corte que mejor se adapta a cada idea, cada material de corte y cada entorno de trabajo.

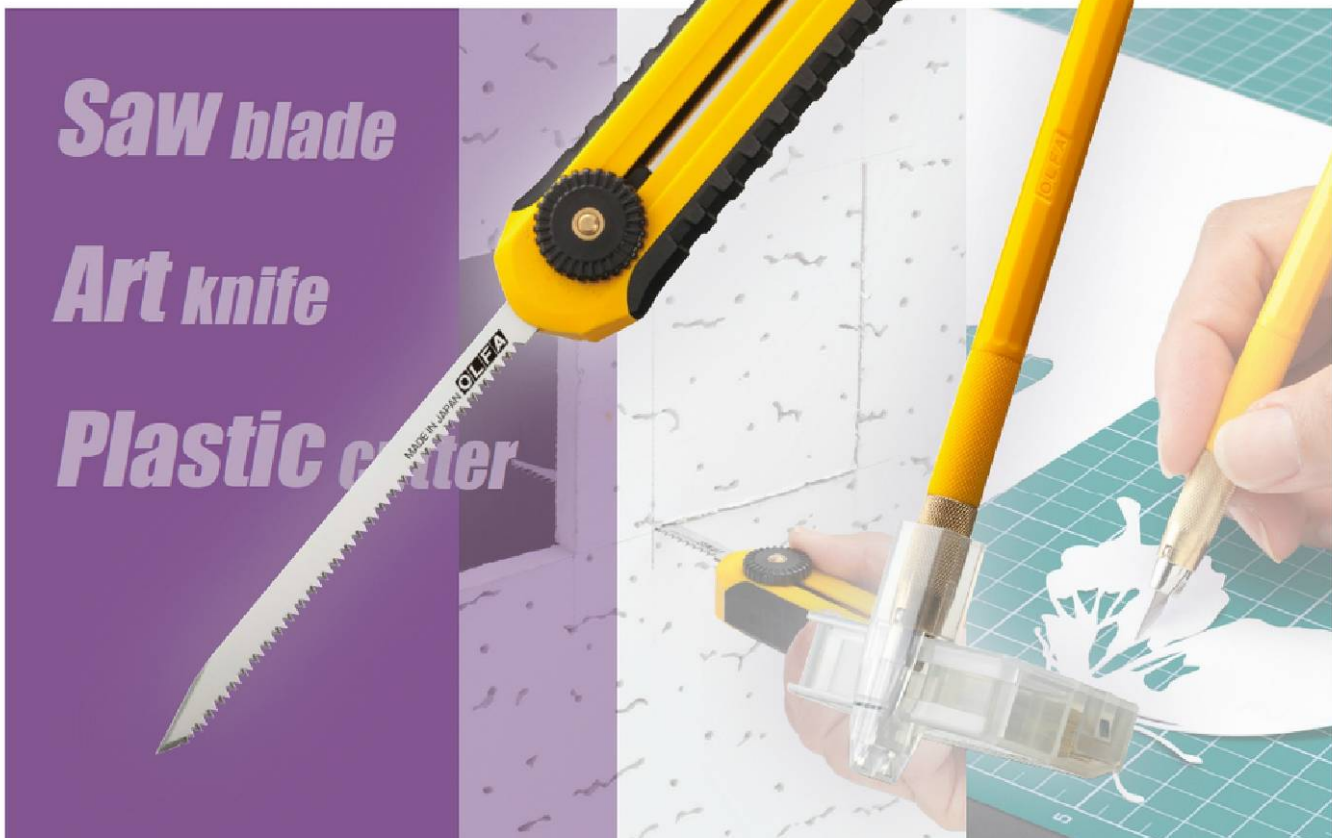



AK-5

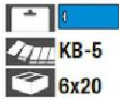

KB-5

6x20



KB-5 x30

x1

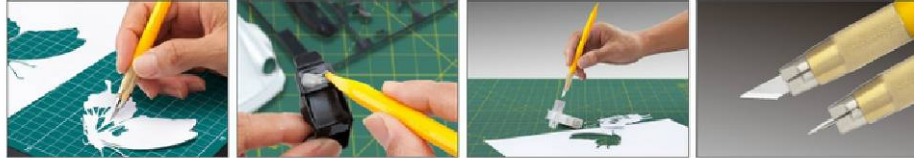

The sharp-pointed blade is perfect for precise cutting.

The spare blade case works as a standish when connected to the blade cover.

- La lame à bout pointu est parfaite pour assurer la précision de coupe. La boîte de lame de rechange fonctionne comme un standish lorsqu'il est connecté au cache de la lame.
- Die Klinge mit scharfer Spitze ist perfekt für präzises Schneiden. Der Ersatzklingenbehälter dient als Ständer, wenn er an der Klingensabdeckung befestigt ist.
- La cuchilla afilada puntiaguda es perfecta para un corte de precisión. El estuche de la cuchilla de repuesto caso funciona como un soporte al conectarla a la cubierta de la cuchilla.

AK-4



KB4-S/-R/-F/-NS/-WS/KB

6x20



KB4-S x2

KB4-F x1

KB4-R x1



KB4-S/100

x100



100 blades packed in economical package.

- 100 lames dans un boîtier d'emballage économique.
- 100 Klingen, die verbrauchsarm verpackt sind.
- 100 cuchillas incluidas en un embalaje económico.

Premium art knife with soft grip.

- Couteau d'art de qualité supérieure avec poignée molle.
- Erstklassiges Kunstmesser mit weichem Griff.
- Cortador artistico premium con mango suave.

Basic art knife.

- Couteau d'art de base.
- Einfaches Kunstmesser.
- Cortador artístico básico.

AK-1



KB x25



AK-1/5B

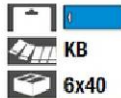

KB x5



CS-5



A combination of Keyhole Saw and 12.5mm Snap-Off Blade Cutter.
2 blades in 1 handle for electricians.

- Une combinaison de scie à cèillet et de lame de cutter détachables de 12,5 mm. 2 lames dans 1 poignée pour les électriciens.
- Eine Kombination von Stichsäge und 12,5-mm-Cutter mit Abknick-Klinge. 2 Klingen in 1 Griff für Elektriker.
- Una combinación de sierra tipo cerradura y un cortador con cuchilla desglosable de 12,5 mm. 2 cuchillas en 1 asa para electricistas.



The bi-directional saw blade cuts while pulled and also while pushed, leaving a clean cut surface.

- La lame de scie bidirectionnelle coupe lorsqu'elle est retirée mais aussi lorsqu'elle est poussée, en laissant une surface de coupe propre.
- Das bidirektionale Sägeblatt schneidet beim Ziehen und ebenfalls beim Drücken und hinterlässt eine saubere Schnittoberfläche.
- La cuchilla de sierra bidireccional corta al tirar de ella y también al empujarla, dejando una superficie de corte limpia.



Awarded as the best new product at Japan DIY Homecenter Show 2013.

- Récompensé en tant que meilleur nouveau produit au Japan DIY Homecenter Show 2013.
- Ausgezeichnet als bestes neues Produkt bei der Japan DIY Homecenter Show 2013.
- Premiado como el mejor gran producto en la feria DIY Homecenter de 2013 en Japón.

UTC-1



SKB-2/RSKB-2/HOB-2

6x20



Tough cutter with thick trapezoid blade.

- Cutter résistant avec lame trapézoïdale épaisse.
- Grobes Messer mit dicker Trapezklinge.
- Cortador resistente con cuchilla trapezoidal gruesa.

SK-3



SKB-2/HOB-2/RSKB-2

6x40



SKB-2 x2



With thick trapezoid blade.

- Avec lame trapézoïdale épaisse.
- Mit dicker Trapezklinge.
- Con cuchilla trapezoidal gruesa.

HOK-1



HOB-1

6x20



Powerful hook cutter.

- Cutter à crochet puissant.
- Kraftvolles Hakenmesser.
- Cortador de gancho potente.

45-C

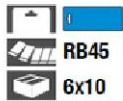

Carpet/Lino cutter.

- Cutter pour moquette/lino.
- Teppich-/Linoleummesser.
- Cortador de moqueta/lino.



Carton cutter with snap-off blade.

- Cutter à carton avec lame sécable.
- Kartonmesser mit Abknick - Klinge.
- Cortador para cartón con cuchilla desglosable.

CTN-1



CTN-1/40

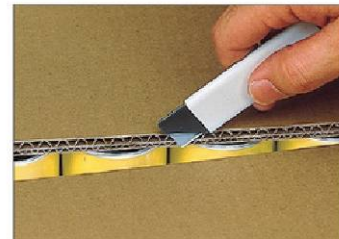

CMP-1



COB-1 x6

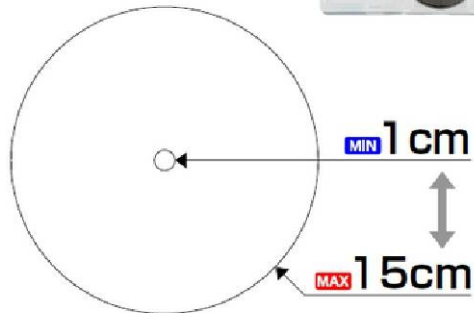

Cuts circles in dia. 1 - 15 cm

- Permet de découper des cercles de 1 à 15 cm de diamètre
- Schneidet Kreise im Durchm. 1 - 15 cm
- Corta círculos en diámetros de 1 a 15 cm

CMP-1/DX



COB-1 x11

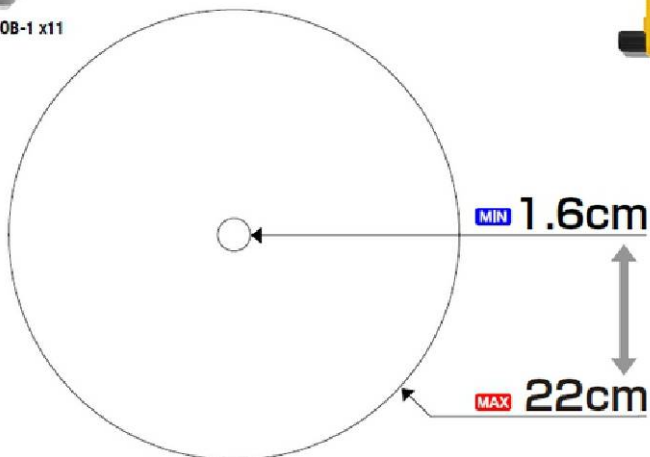
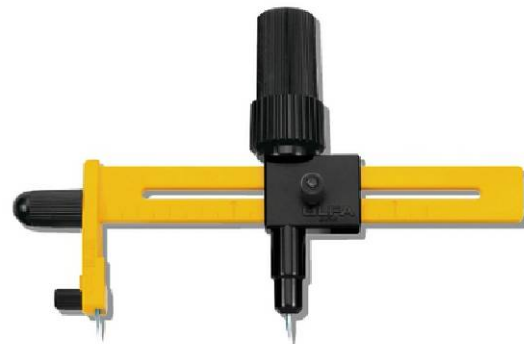

Ratchet circle cutter in dia. 1.6 - 22 cm

- Cutter rotatif à rochet de diamètre de 1,6 à 22 cm
- Knarrenkreismesser im Durchm. 1,6 - 22 cm
- Cortador con carrete que corta círculos de diámetro de 1,6 a 22 cm

TS-1



paperworld & creativeworld
Creative Impulse 2012



Incredible, cuts only the top sheet.

- Incroyable, permet de ne couper que la feuille supérieure.
- Unglaublich, schneidet nur das obere Blatt.
- Increible, corta únicamente la hoja superior.



PRC-3



Powerful perforation cutter.

- Cutter de perforation puissant.
- Kraftvolles Lochungsmesser.
- Cortador de perforación potente.



PRC-2

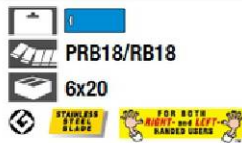

Handy perforation cutter.

- Cutter de perforation maniable.
- Handliches Lochungsmesser.
- Cortador de perforación práctico.



Plastic Cutters housing 2 extra blades inside. Score on plastic plate to break off.

- Cutters en plastique avec 2 lames supplémentaires. Notation sur plaque en plastique pour découpe.
- Plastikmesser mit 2 extra Klingen. Zum Abbrechen auf Kunststoffplatte anritzen.
- Cortadores de plástico con 2 cuchillas adicionales. Raya placas de plástico para posteriormente romperlas.

PC-L



PC-S

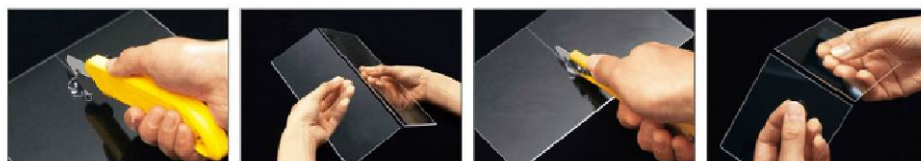

MC-45

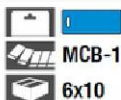

MC-45/2B

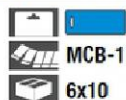

45° oblique cutting, for picture mounts.

- Coupe oblique à 45°, pour montage d'image.
- 45° Schrägschneiden, für Bildhalterungen.
- Corte oblicuo de 45°, para foto montajes.

MC-45/DX

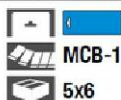

Advanced model "DX" with guide ruler.

- Modèle perfectionné avec règle de repère.
- Erweitertes Modell mit Führungslinial.
- Modelo avanzado con regla guía.



CK-1

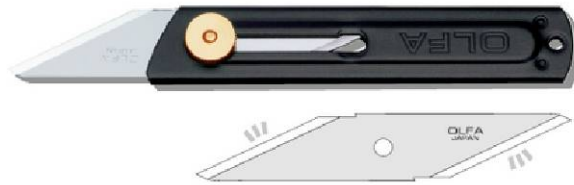
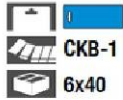

Both edges can be used.

- Les deux bords peuvent être utilisés.
- Beide Klingen können verwendet werden.
- Se pueden usar ambos filos.

CK-2



All stainless steel model.

- Tous les modèles sont en acier inoxydable.
- Modell komplett aus Edelstahl.
- Todos los modelos son de acero inoxidable.

TK-3M/24



Magnetic Touch Knife.

- Couteau tactile magnétique.
- Magnetisches Kontaktmesser.
- Cortador magnético de bolsillo.

Pocket-sized, ideal for private imprinting.

- Format de poche, idéal pour l'impression privée.
- Taschenformat, ideal für private Einprägungen
- A tamaño bolsillo, ideales para la impresión privada.

TK-4/60



TK-4/32



Create your own TK-4 by imprinting your name!

- Créer votre propre TK-4 par impression de votre nom!
- Kraieren Sie Ihr eigenes TK-4, indem Sie Ihren Namen aufdrucken!
- ¡Cree sus propios TK-4 imprimiendo su nombre!

Cutting Mats

■ Tapis de coupe ■ Schneidmatten ■ Felpa de corte

Self-healing cutting mats designed by the originator of the snap-off blade cutter, especially for use with OLFA snap-off blade cutters, art knives and rotary cutters. Comfortable double-sided mats protect cutting surfaces and improve the blades' life as well.

- Tapis de coupe auto-cicatrisant conçus par l'auteur du cutter avec lame sécable, en particulier pour l'utilisation avec cutters avec lame sécable OLFA, couteaux d'art et cutters rotatifs. Tapis de coupe de surface recto verso confortable protège les surfaces de coupe et améliore également la durée de vie des lames.
- Sich selbst reparierende Schneidunterlagen, entworfen vom Urheber der Abknick-Klinge, speziell für die Verwendung mit OLFA Cuttern mit Abknick-Klingen, Kunstmessern und Rotationscuttern. Komfortable doppelseitige Matten schützen die Schneidoberflächen und verlängern ebenfalls die Lebensdauer der Klingen.
- Alfombrillas de corte con autoreparación diseñadas por el creador del cortador con cuchilla desglosable, especialmente para usar con cortadores OLFA de cuchilla desglosable, cuchillos para arte y cortadores rotatorios. Las confortables alfombrillas de dos lados protegen las superficies de corte y mejoran también la vida útil de la cuchilla.



Rotating Mats

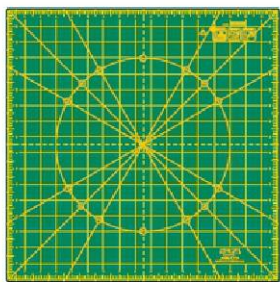

RM-17S / Scale: Inches

	17" x 17"		3x3	
	12" x 12"		3x8	
	30cmx30cm		3x8	

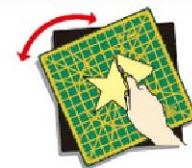

360° rotating for scrap booking, paper crafts, quilting and modelling.

- Rotation à 360° pour scrapbooking, arts du papier, matelassage, modelage.
- 360° drehend für Sammelalben, Papierhandwerke, Quilts, Modellbau.
- Giro de 360° para el desgarre de libros, manualidades, costura, modelado.

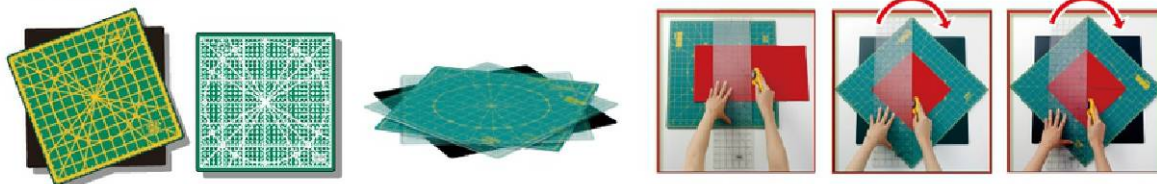

Folding Mats



FCM-12x17
FCM-17x24

MAT 32cmx45cm

MAT 32cmx23cm

6x8

MAT 45cmx62cm

MAT 45cmx31.5cm

6x4

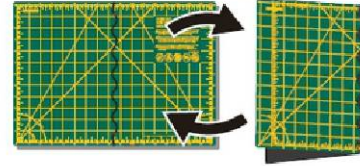

User- and eco-friendly olefin mats are half size when not in use.
Smaller folded size makes Mat more portable.

- La plaque de coupe écologique à base d'Oléfine est très pratique car se replie en deux pour le rangement. Une fois repliée, sa taille réduite la rend nomade.
- Die Verbraucher- und umweltfreundlichen Olefin Matten lassen sich auf ihre halbe Größe zusammenfalten und sind dadurch besser zu transportieren.
- Usuarios y amigos de lo ecológico las planchas "olefin" tienen la mitad del tamaño cuando no se están utilizando. Las planchas dobladas son más pequeñas y más fáciles de transportar.

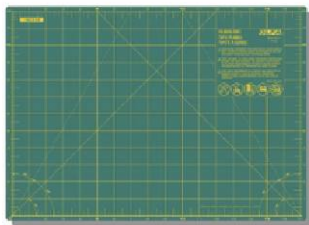
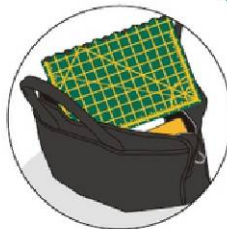
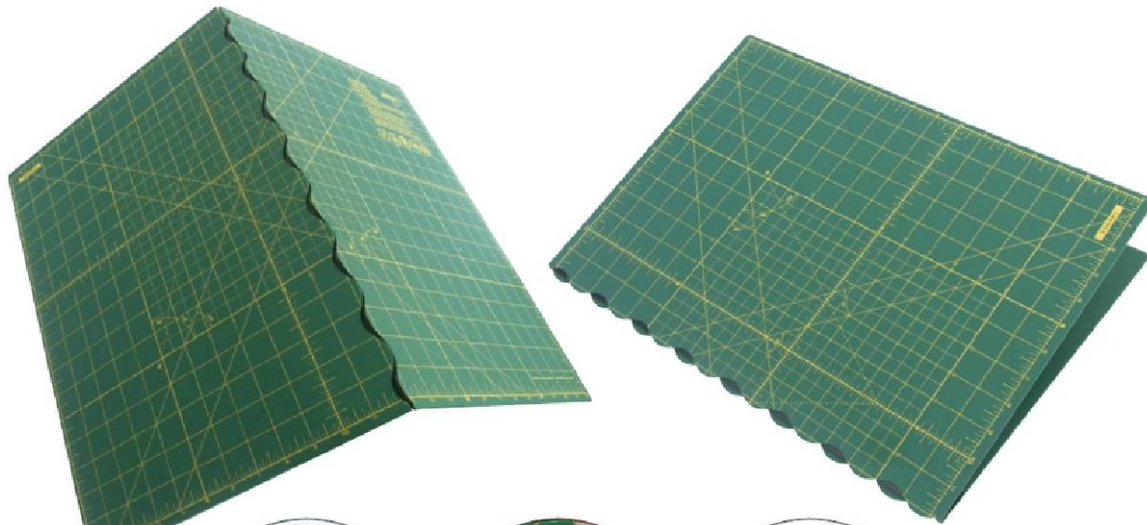

New

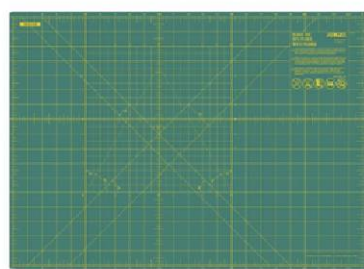

New



The A3 sized FCM 12x17 features nonslip backing for cutting stability.

- Son dos antiglisse apporte a la plaque A3 (12x17 cm) une grande stabilité de découpe.
- Die Größe A3 (FCM 12x17) verfügt über eine Antirutsch-Rückseite für stabiles Schneiden.
- Tamaño A3 FCM medidas 12x17 para mejorar la estabilidad durante el corte no incluyen antideslizante en la parte trasera.

thickness: 3mm

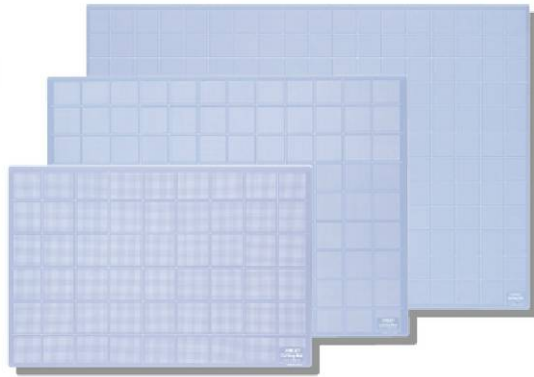
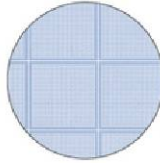
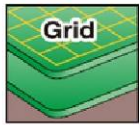

- TCM-L**  90cmx62cm/35"4x24"4  5 pcs.
- TCM-M**  62cmx45cm/24"4 x17"7  10 pcs.
- TCM-S**  45cmx30cm/17"8 x 11"8  20 pcs.

Double-sided use. Translucent mat.

-  Utilisation recto-verso. Matériaux translucides.
-  Doppelseitige Verwendung. Durchsichtige Matte.
-  Uso bilateral. Felpa translúcido.

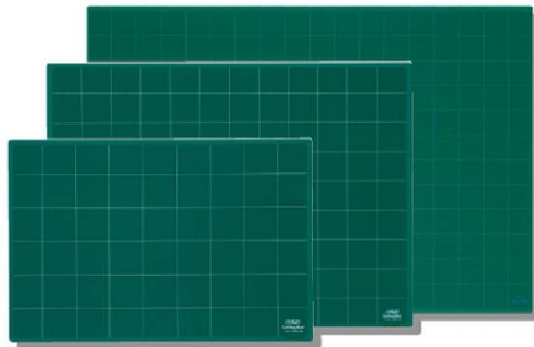
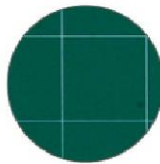

- NCM-L**  90cmx62cm/35"4x24"4  5 pcs.
- NCM-M**  62cmx45cm/24"4 x17"7  10 pcs.
- NCM-S**  45cmx30cm/17"8 x 11"8  20 pcs.



Double-sided use. Green mat.

-  Utilisation recto-verso. Matériaux écologiques.
-  Doppelseitige Verwendung. Grüne Matte.
-  Uso bilateral. Felpa verde.

thickness: 2mm





Grid Lines for Measurement

-  Lignes de la grille pour la mesure
-  Gitterlinien für Messungen
-  Líneas de la rejilla para medición

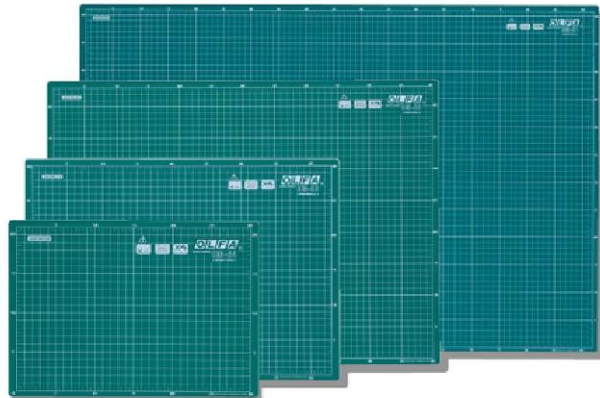
- CM-A1**  92cmx61cm/36"x24"  5x2
-  94cmx63cm/37"x24"8
- CM-A2**  60cmx43cm/23"x17"  5x4
-  62cmx45cm/24"4x17"7
- CM-A3**  43cmx30cm/17"x12"  5x12
-  45cmx32cm/17"7x12"6
- CM-A4**  30cmx21cm/12"x8"  5x20
-  32cmx22.5cm/12"6x8"9



Most suitable for hobby & craft work.
Double-sided use.(Cm/Inch)

-  Très approprié pour le bricolage et le travail artisanal. Utilisation recto-verso. (Cm/Pouce)
-  Am besten geeignet für Hobby & Handwerksarbeiten. Doppelseitige Verwendung. (Cm/Zoll)
-  Excelentes para hobbies y trabajos de artesanía. Uso bilateral. (Cm/Pulgadas)

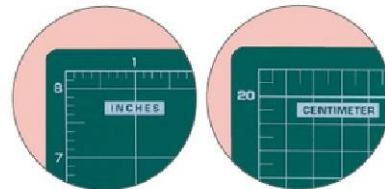

thickness: 1.5mm

Grid Lines for Measurement

- Lignes de la grille pour la mesure
- Gitterlinien für Messungen
- Líneas de la rejilla para medición

Designed to use with Rotary Cutters. Self-healing triple-layer mats.

- Conçus pour être utilisés avec des cutters rotatifs. Tapis triple couche auto-cicatrisant.
- Entwickelt für die Verwendung mit Rundmessern. Selbstreparierende Dreifach-Schichtmatte.
- Diseñados para su uso con los cortadores rotativos. Felpa de triple capa de auto reparación.



RM-MG 36"x24" 94cmx63cm/37"x24"8 5 pcs.

RM-SG 24"x18" 63cmx47cm/24"8x18"5 5x4

RM-CG 18"x12" 45cmx30cm/18"5x12"6 5x8

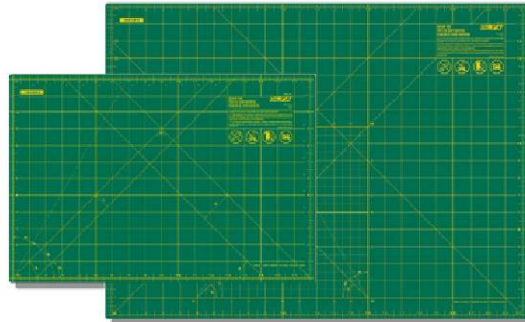

RM-IC-M 90cmx60cm/36"x24" 94cmx63cm/37"x24"8 5x2

RM-IC-S 60cmx45cm/24"x18" 63cmx47cm/24.8"x18"5 5x4

RM-IC-C 45cmx30cm/18"x12" 47cmx32cm/18"5x12"6 5x8

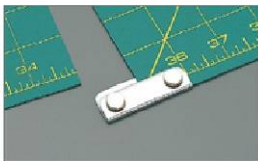

RM-CLIPS/2 1x3

70"x23" 180cmx60cm/70"9x23"6

RM-CLIPS/3 1x2

70"x35" 180cmx90cm/70"9x35"4

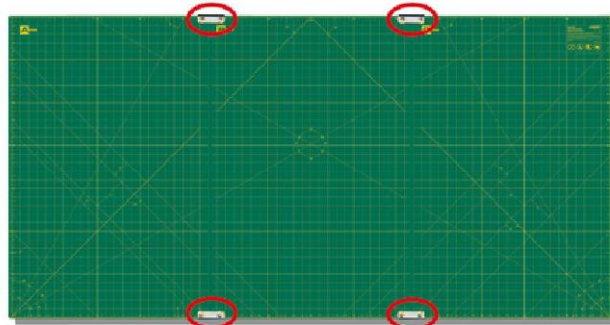
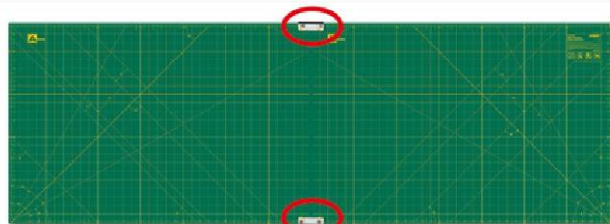

To protect larger working surface.

- Permettent de protéger une surface de travail plus grande.
- Schützt größere Arbeitsoberflächen.
- Protege una mayor superficie de trabajo.



- Keep mats away from direct sunlight and heat.
- Ne pas exposer ces plaques à la chaleur ou à la lumière du soleil.
- Halten Sie diese Unterlagen stets von Sonnenlicht und Hitze fern.
- Mantenga estas planchas siempre alejadas de los rayos solares y del calor.



- Do not leave mats in autos.
- Ne pas laisser les tissus dans les autos.
- Die Matten nicht im Auto lassen.
- No deje las alfombrillas dentro de coches.



- Mats must be stored flat.
- Les plaques doivent être entreposées à plat.
- Die Unterlagen müssen flach aufbewahrt werden.
- Las planchas deben guardarse de forma que queden planas.



- Not suitable for use with steam irons.
- Ne pas utiliser avec un fer à repasser à vapeur.
- Sie eignen sich nicht für die Verwendung mit Dampfbügeleisen.
- No son apropiadas para uso con planchas de vapor.

Spare Blades

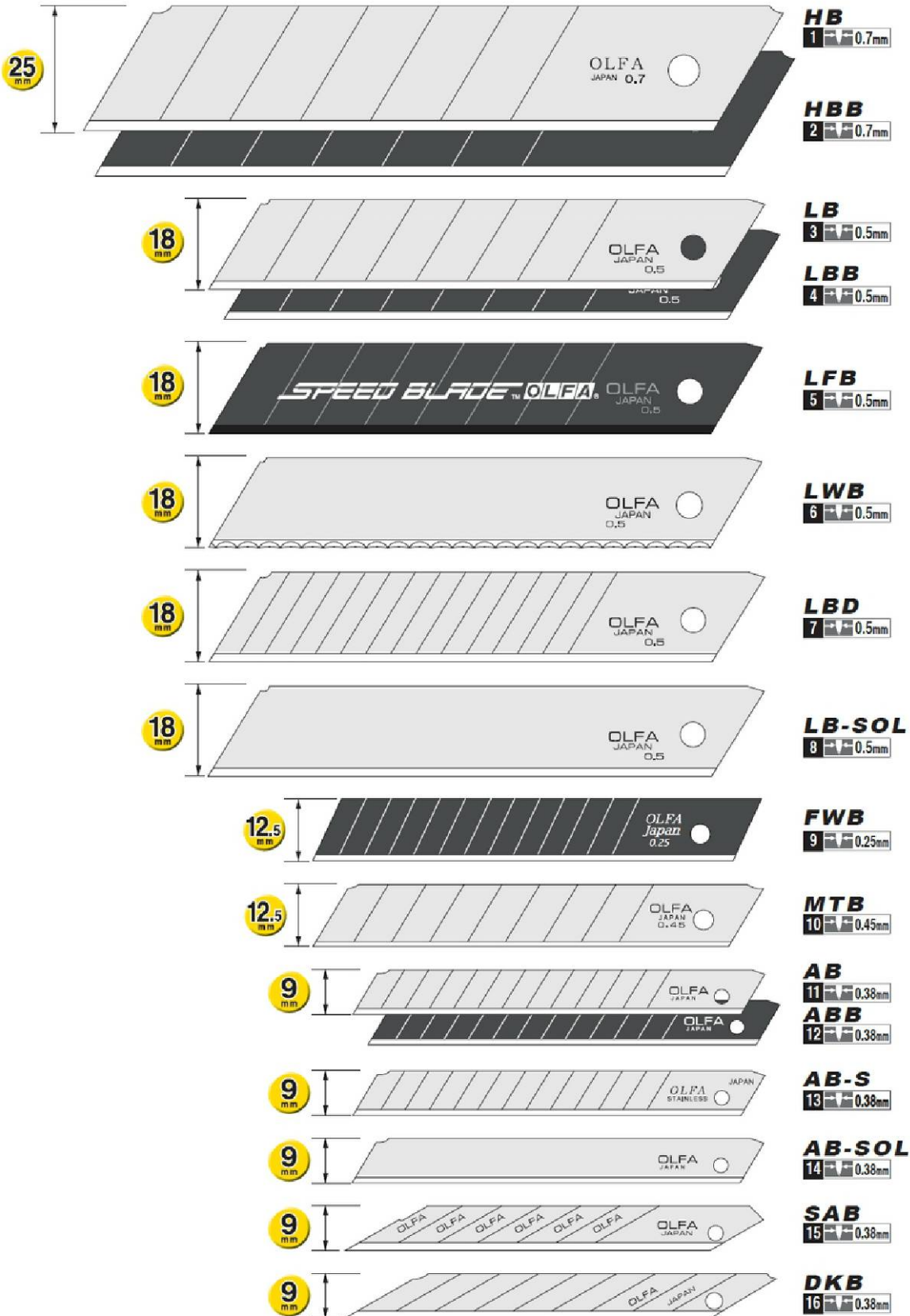

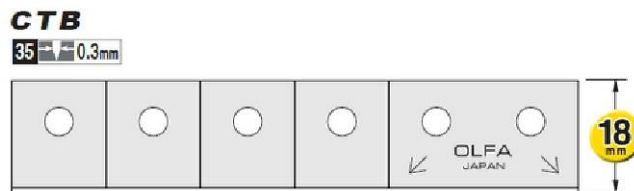
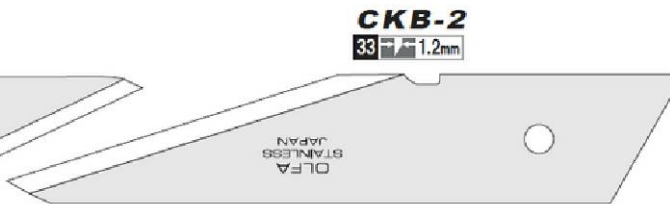
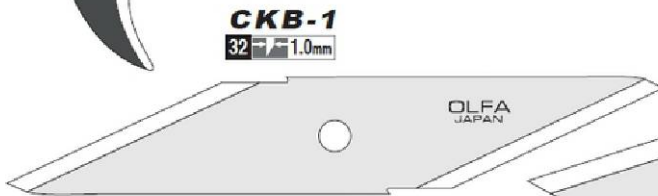
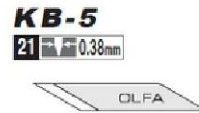

RB18

36 0.3mm



18 mm

RB28

37 0.3mm



28 mm

RB45

38 0.3mm



45 mm

PRB18

39 0.3mm



18 mm

PRB28

40 0.3mm



28 mm

RB60

41 0.35mm

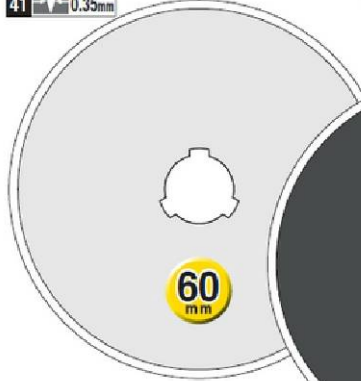

60 mm

CHB

42 0.35mm



60 mm

WAB45

43 0.4mm



45 mm

PIB45

44 0.4mm

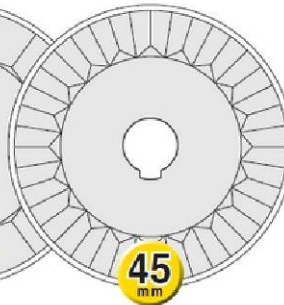

45 mm

RSKB-2

45 0.6mm



SKB-2

46 0.6mm

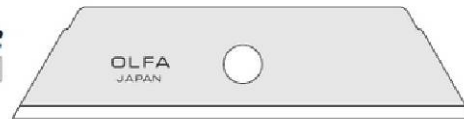

SKB-7

47 0.4mm



SKB-8

48 0.4mm



SKB-10

49 0.4mm



BTB-1

50 0.6mm

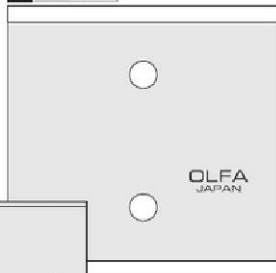

BS08

53 0.8mm



BS

54 0.5mm



TB-45

52 0.45mm

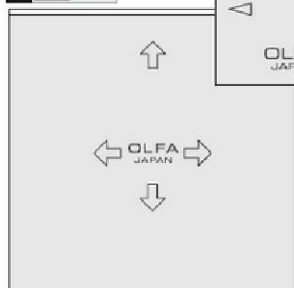

TB-25

51 0.3mm

BSF

55 0.45mm



■ Model Number
■ Numéro du Modèle
■ Modell Nummer
■ Numero de Modelo

■ Packaging
■ Emballage
■ Verpackung
■ Embalaje

■ Contents
■ Contenu
■ Kartoinhalt
■ contenido

■ Carton Contents
■ Contenu de Carton
■ Kartoinnhalt
■ Contenido de Embalaje

■ Blister Packed
■ Emballage Blister
■ Blister Packung
■ Presentado en Blister

■ Plastic Case
■ Étui Plastique
■ Kunststoffbox
■ Caja de Plástico

■ Plastic Bag
■ Sachet Plastique
■ Kunststoffbeutel
■ Bolsa de Plástico



1 HB			
HB-5B		5	6x20
HB-20		20	6x10

2 HBB			
HBB-5B		5	6x20

3 LB			
LB-6B		6	6x40
LB-10		10	6x40
LB-10B		10	6x20
LB-50		50	6x10
LB-50B		50	6x6

4 LBB			
LBB-10		10	6x40
LBB-10B		10	6x20
LBB-50		50	6x10

5 LFB			
LFB-5B		5	6x20

6 LWB			
LWB-3B		3	6x20

7 LBD			
LBD-10		10	6x40
LBD-50		50	6x10

8 LB-SOL			
LB-SOL-10		10	6x40

9 FWB			
FWB-10		10	6x20

10 MTB			
MTB-10B		10	6x40

11 AB			
AB-6		6	10x60
AB-10		10	6x80
AB-10B		10	6x40
ASB-10		10	12x60
AB-50		50	6x20
AB-50B		50	6x20

12 ABB			
ASBB-10		10	12x60
ABB-10B		10	6x40
ABB-50		50	6x20

13 AB-S			
AB-10S		10	6x80
AB-50S		50	6x20

14 AB-SOL			
AB-SOL-50		50	6x20

15 SAB			
SAB-10		10	10x60
SAB-10B		10	6x40

16 DKB			
DKB-5		5	100x10

17 HSWB-1			
HSWB-1/1B		1	6x20

18 SWB-5			
SWB-5/1B		1	6x20

19 COB-1			
COB-1		15 (3x5)	6x40

20 KB			
KB		25	6x40

21 KB-5			
KB-5/30B		30	6x40

22 KB4-S			
KB4-S/5		5	6x40
KB4-S/100		100	10x5

23 KB4-R			
KB4-R/5		5	6x40

24 KB4-F			
KB4-F/5		5	6x40

25 KB4-NS			
KB4-NS/3		3	6x40

26 KB4-WS			
KB4-WS/3		3	6x40

27 TSB-1			
TSB-1		5	6x40

28 PB-450			
PB-450		5	6x40

29 PB-800			
PB-800		3	6x40

30 HOB-1			
HOB-1		1	6x40

31 HOB-2			
HOB-2/5		5	24x10

32 CKB-1			
CKB-1		2	6x40

33 CKB-2			
CKB-2		2	6x40

34 MCB-1			
MCB-1		5	6x40

35 CTB			
CTB-5		5	24x20
CTB-30		30	12x10

36 RB18			
RB18-2		2	6x80

37 RB28			
RB28-2		2	6x80
RB28-10		10	6x10

38 RB45			
RB45-1		1	6x80
RB45-10		10	6x10

39 PRB18			
PRB18-2		2	6x80

40 PRB28			
PRB28-2		2	6x40

41 RB60			
RB60-1		1	6x40

42 CHB			
CHB-1		1	6x20

43 WAB45			
WAB45-1		1	6x40

44 PIB45			
PIB45-1		1	6x40

45 RSKB-2			
RSKB-2/5		5	6x40

46 SKB-2			
SKB-2/5B		5	6x40

47 SKB-7			
SKB-7/10B		10	6x40

48 SKB-8			
SKB-8/10B		10	6x40

49 SKB-10			
SKB-10/10B		10	6x40

50 BTB-1			
BTB-1		3	6x40

51 TB-25			
TB-25		10	6x40

52 TB-45			
TB-45		4	6x40

53 BS08			
BS08-6B		6	6x20

54 BS			
BS-10B		10	10x20

55 BSF			
BSF-6B		6	6x10



THE ORIGINATOR SINCE 1956



OLFA CORPORATION

Higashi-Nakamoto 2-11-8, Higashinari-Ku,
OSAKA 537-0021, JAPAN
Phone: +81-(0)6-6972-8104
F a x: +81-(0)6-6972-7400

OLFA reserves the right to discontinue the sale of any products and to change the specification without prior notice to you or any other third party. OLFA shall not be liable for any claims or damages arising in connection with products sold prior to such change being implemented.

Entire contents copyright OLFA CORPORATION All rights reserved.

01506-DS